

# ACCESSORIES, ACCESSORIES FOR SINKS, KITCHEN ACCESSORIES, KITCHEN SINK ACCESSORIES ACCESSORIES

## PRODUCT INFORMATION

. POSITION

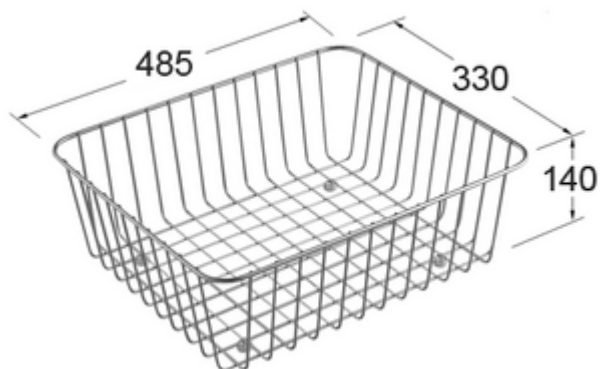

Model	8K0910
Weight	1,5 kg
Description	Accessory set comprising: : a universal cutting board made of beech, a stainless steel salad basket

## COLOURS

8K091000 4051202362140