

ACCESSORIES, ACCESSORIES FOR SINKS, KITCHEN ACCESSORIES, KITCHEN SINK ACCESSORIES ACCESSORIES

PRODUCT INFORMATION

. POSITION

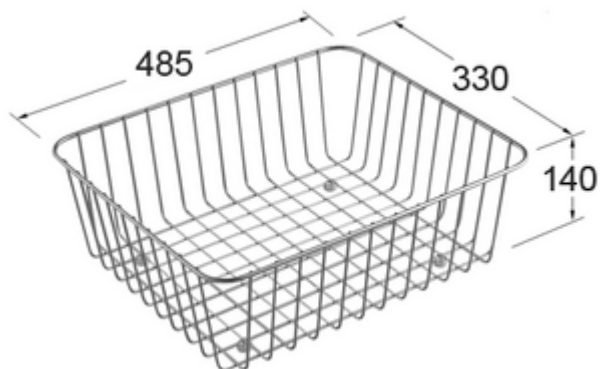

Model	8K3100
Weight	0,862 kg
Description	Salad basket

COLOURS

Stainless steel	8K3100K1	4051202301514
-----------------	----------	---------------